

From the customer's point of view . . .

Table Spot welder

MYSPOT

EasySetting®



ENGINEERING & PRODUCT DEVELOPMENT  A BENDING EXPERT
koyo giken

特許番号:3944297,3815617,3445636,2085630,1693984,1693994,PCT/JP2003/00829/PAT.P 54件 2008年3月現在

MATERIALS

A New
Generation

One
Two
Spot!

MYSPOT

MATERIALS	
MILD STEEL	USER'S DATA
GALVANNEAL	✓
STAINLESS	✓
GALVANIZED	✓

THICKNESS (mm)	
t=0.8	t=2.0
t=1.0	t=2.3
t=1.2	
t=1.5	



EasySetting®



EasySetting system is available for all MYSPOT models

Select materials and thickness

- Alternate current transformer
- Rectified current transformer
- Inverter transformer

EasySetting®

ADVANTAGES OF MYSPOT

- | | |
|-------|--|
| No. 1 | Set welding parameters with two touches (material and thickness) |
| No. 2 | Pressure setting also automatic |
| No. 3 | Water and air flow check indicator equipped |
| No. 4 | Tip dress interval counter equipped |
| No. 5 | It's as easy as "One, Two, Spot!" |

EasySetting®

- **Preset welding parameters** Select material type and thickness: welding date is accessed automatically
- **User-adjustable presets** Adjust preset data and store as User data (20 programs)
- **Spot counter equipped** On-board counter automatically prompts tip dressing and tracks number of welds performed and number of workpieces completed
- **Self-diagnostic system** Equipped with a cooling cable diagnostic system
- **Error history** Error history is automatically recorded and can be traced for quality control.
- **Automatic data updates** Parameters for new materials are available from Koyo Giken through the Internet and can be installed with EasyComm system.



A high-productivity TABLE SPOT WELDER comparable productivity to NC robots

<Vertical Gun (V-Gun)>

- Allows deep bottom welding
- 360-degree arm rotation
- 350 or 500mm stroke
- Nut welding
- Screw welding

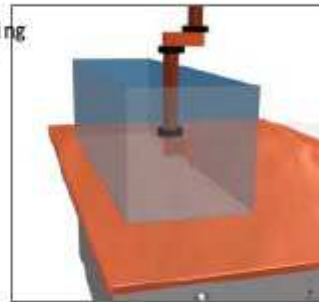

Simply place a workpiece anywhere on the table and weld



<Horizontal Gun (H-Gun)>

- Allows deep width welding
- Gun length: 320 or 690mm
- Nut welding



Ideal for high mix low volume production



No need to hold workpiece; place directly on the table

- Simply position gun over points to be welded
- Gun can be easily maneuvered over and around obstacles
- Articulated arms allow fast, easy handling



Upright worker stance enables continuous operation without fatigue

- Stable productivity with high quality
- Can be readily operated by unskilled workers
- Reduce putty work and grinding

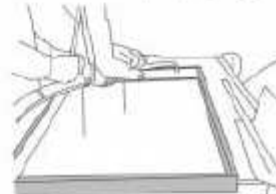

Elimination of workpiece distortion

- Welding dents are minimized on the table side
- Spot welds are precise and repeatable



V-Gun available especially for boxy workpieces

- V-Gun can reach deep into workpieces
- Handle operation enables easy 360-degree gun rotation

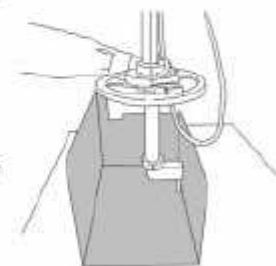



NK-03HV100-15-D-EZ

03 Series

[SPECIFICATIONS]

RATED CAPACITY : 80kVA AC380~420V 1Φ
50/60Hz
(AC480V 60Hz 1Φ for U.S.)
GUN TYPE : HORIZONTAL, VERTICAL
MAXIMUM CURRENT: H: 11000 Amp, V: 12000 Amp
TABLE SIZE : t15 × 1000 × 1500mm
COOLING UNIT : ON BOARD

21 Series

[SPECIFICATIONS]

RATED CAPACITY : 80kVA AC380~420V 1Φ
50/60Hz
(AC480V 60Hz 1Φ for U.S.)
GUN TYPE : HORIZONTAL, VERTICAL
MAXIMUM CURRENT: H: 11000 Amp, V: 12000 Amp
TABLE SIZE : t15 × 800 × 1000mm
TABLE STROKE : 200mm (H650~850mm)
COOLING UNIT : ON BOARD



NK-21HEV810-M-I-EZ

MYSLOT ADVANTAGES

Provides high-quality spot welds

- Better quality compared to conventional spot welding technologies
- produces minimal weld dents on table side

Reduces preparation time

- Fewer tips required for normal production
- EasySetting feature sets reference welding parameters automatically

Technical support available

- Qualified technical support and system maintenance support available

Easy to fit into your production line

- All-in-one unit fits into any production line

Aluminum spot welding system available

- Aluminum (5052) t2.0mm x t2.0mm could be welded (NK-21HE810-M-AH4)

Increases productivity up to 200% or more

- Utilization of jigs and multiple MySpot units provides ultimate productivity

Environmentally friendly

- Eliminates harmful fumes and gases common to arc welding

Easy transportation & installation

- All-in-one unit, even water cooling system is on-board

Welds nuts and screws

- Special tips available for welding nuts and screws



Comparison of operating efficiency between MYSPOT and conventional spot welders

JOB Data of <MYSPOT> in Steel Desk Production Process

	Conventional	<MYSPOT>
Production/day	190 desks	310 desks
Personnel	6	4
Working	10x6-60H	10x4-40H
Working	18.9min	7.7min
Cost reduction		(18.9-7.7)/18.9 ≈0.59 (59% less)
Finishing time	4 min/unit	0 min/unit (100% less)
Environment	Dust from secondary process	clean
Skill	Required	Not required
Quality	Inconsistent	Consistent

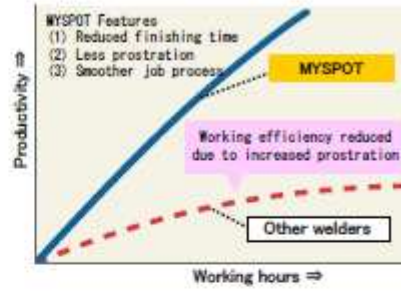

MYSPOT USERS



ANTI-OXIDATION SYSTEM (for stainless steel)

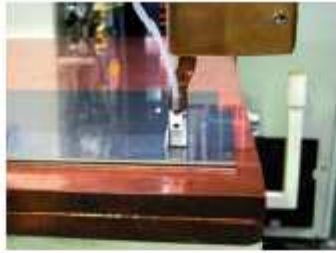

Anti-Oxidation system is effective only for SUS

NUT WELDING BY HORIZONTAL GUN

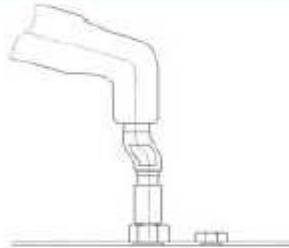

M6~M12 M4~M6

Nut Welding

Flange-type nut provide greater strength and less thread distortion, due to distribution of current through the nut's flange

NUT, SCREW WELDING BY VERTICAL GUN



●No spatters and less toxic gas emission



M6~M12 M4~M6

Nut Welding

Flange-type nut provide greater strength and less thread distortion, due to distribution of current through the nut's flange

PROPOSITIONS FOR CUSTOM APPLICATIONS (Special JIGs • Engineering • Special Machines)

- Designing special jigs for complex shaped workpieces
- Designing and engineering special machines for special applications

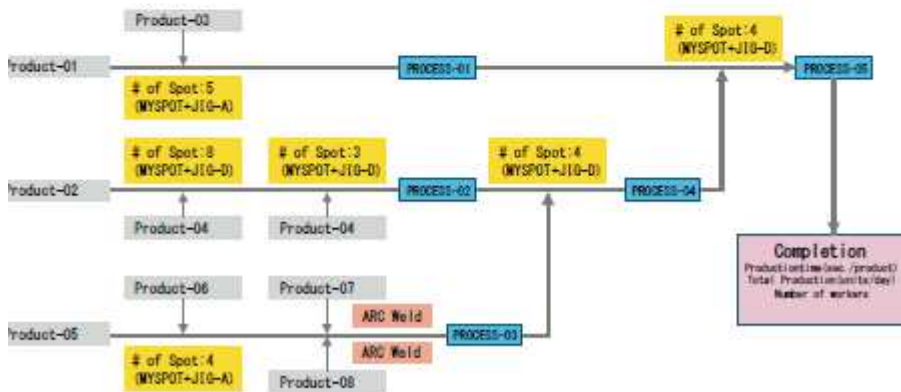
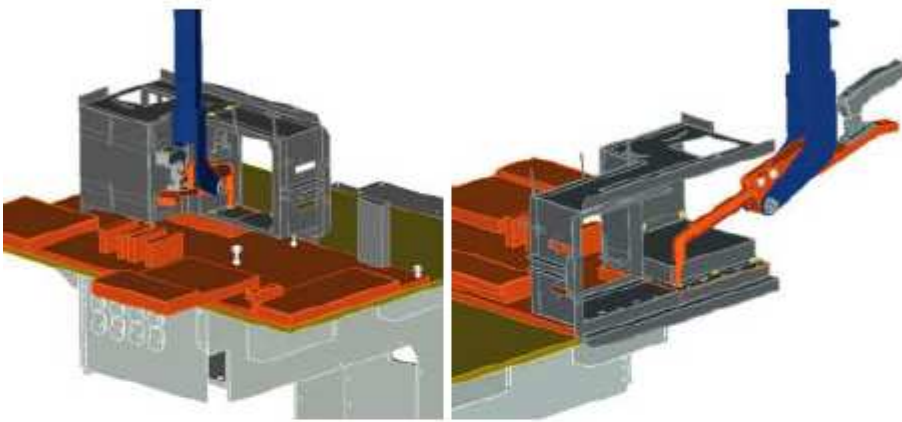

Application of using fixtures

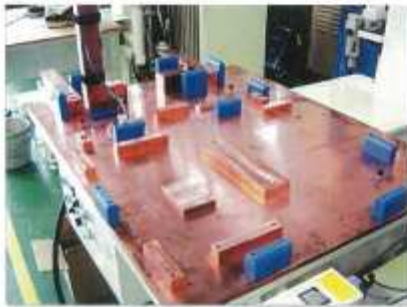

Even Non-Flat workpieces can be welded with simple fixtures on the table.



MYSLOT enables welding in unusually tight spaces.



The MYSLOT system is fast, flexible, and userfriendly.

MYSPOT International Models

21 Series



NK-21HE810-M NK-21H810-M-D NK-21V810-D

Table Size : 800mm (31.5") x 1000mm (39.3")
 Gun Type : Horizontal or Vertical Gun
 Integrated cooling unit for easy transport.

Model	Rated Capacity	Gas Type	Max. Welding Current	Air Pressure	Electrode Force	Table Size
NK-21HE810-M	36kVA	H	10000A	0.5Mpa (7.26psi)	2.2kN (490lbf)	800x1000
NK-21H810-M-D	36kVA	H	11000A	0.5Mpa (7.26psi)	2.2kN (490lbf)	800x1000
NK-21V810-D	36kVA	V	12000A	0.5Mpa (7.26psi)	2.2kN (490lbf)	800x1000

Welding Capacity:
 Mild Steel 2.3x2.3mm (0.91x0.91"); Galvanized 2.3x2.3mm (0.91x0.91");
 Stainless 2.5x2.5mm (0.91x0.91"); Galvanized 2.3x2.3mm (0.91x0.91").

For Aluminum (AL. 5052)



NK-21HE810-M-WKG

Table Size : 800mm (31.5") x 1000mm (39.3")
 Gun Type : Horizontal Gun
 MYSPOT for 2.0x2.0mm (0.79x0.79") Aluminum Sheet with Inverter-type Transformer.
 3.8kN Cylinder, Maximum Welding Current 24,000Amps.
 Integrated cooling unit for easy transport.

Model	Rated Capacity	Gas Type	Max. Welding Current	Air Pressure	Electrode Force	Table Size
NK-21HE810-M-WKG	36kVA	H	24000A	0.5Mpa (7.26psi)	3.8kN (833lbf)	800x1000

Welding Capacity:
 Aluminum (AL5052) 2.0x2.0mm (0.79x0.79")
 Mild Steel 3.2x3.2mm (1.26x1.26"); Galvanized 3.2x3.2mm (1.26x1.26");
 Stainless 3.0x3.0mm (1.18x1.18"); Galvanized 3.2x3.2mm (1.26x1.26").

03 Series



NK-03H100-15-D NK-03V100-15-D

Table Size : 1000mm (39.3") x 1500mm (59.0")
 Gun Type : Horizontal or Vertical Gun
 Integrated cooling unit for easy transport.

Model	Rated Capacity	Gas Type	Max. Welding Current	Air Pressure	Electrode Force	Table Size
NK-03H100-15-D	36kVA	H	11000A	0.5Mpa (7.26psi)	2.2kN (550lbf)	1000x1500
NK-03V100-15-D	36kVA	V	12000A	0.5Mpa (7.26psi)	2.2kN (550lbf)	1000x1500

Welding Capacity:
 Mild Steel 2.3x2.3mm (0.91x0.91"); Galvanized 2.3x2.3mm (0.91x0.91");
 Stainless 2.5x2.5mm (0.91x0.91"); Galvanized 2.3x2.3mm (0.91x0.91").

NOTE: Materials referenced above can vary slightly by manufacturer and country of origin. KOYO GIKEN INC. guarantees the performance of MYSPOT spot welders, but cannot guarantee individual material specifications or thicknesses.

MYSPOT Solutions

The advantage of MYSPOT is broad coverage of the parts to be welded. Equipped with the vertical gun, MYSPOT can make deep welds, where conventional welders cannot. MYSPOT is available with the H-Gun for horizontal movement, V-Gun for vertical movement, as well as with a combination of the H-Gun and V-Gun to suit your needs. While table size may be selected from the standard options above, both size and layout may also be individually customized to fit your production needs.

KOYOGIKEN INC. 4020-4, Tana-Sagamihara-Shi, Kanagawa-Pref. JAPAN TEL+81-42-760-4306 FAX760-4309
 URL <http://www.koyogiken.co.jp> E-Mail: info@koyogiken.co.jp

